



Australian Government



River Modelling for the Murray-Darling Basin

1 Sep 2010

Andy Close
Water Resources Group
Murray Darling Basin Authority

History of River Murray Modelling

1902 – Manual modelling of Cumbaroona Storage 1891-1902

1965 – Initial development of River Murray Model – Dartmouth Vs Chowilla

1975 – First Salinity models

1982 – Water Accounting

1988 – Salinity and Drainage Strategy

1995 – Cap on diversions

2000's – Environmental Flows

2008 – Sustainable Yields Study

2009/10 – Basin-wide modelling for Basin Plan



Australian Government



Murray-Darling Basin System

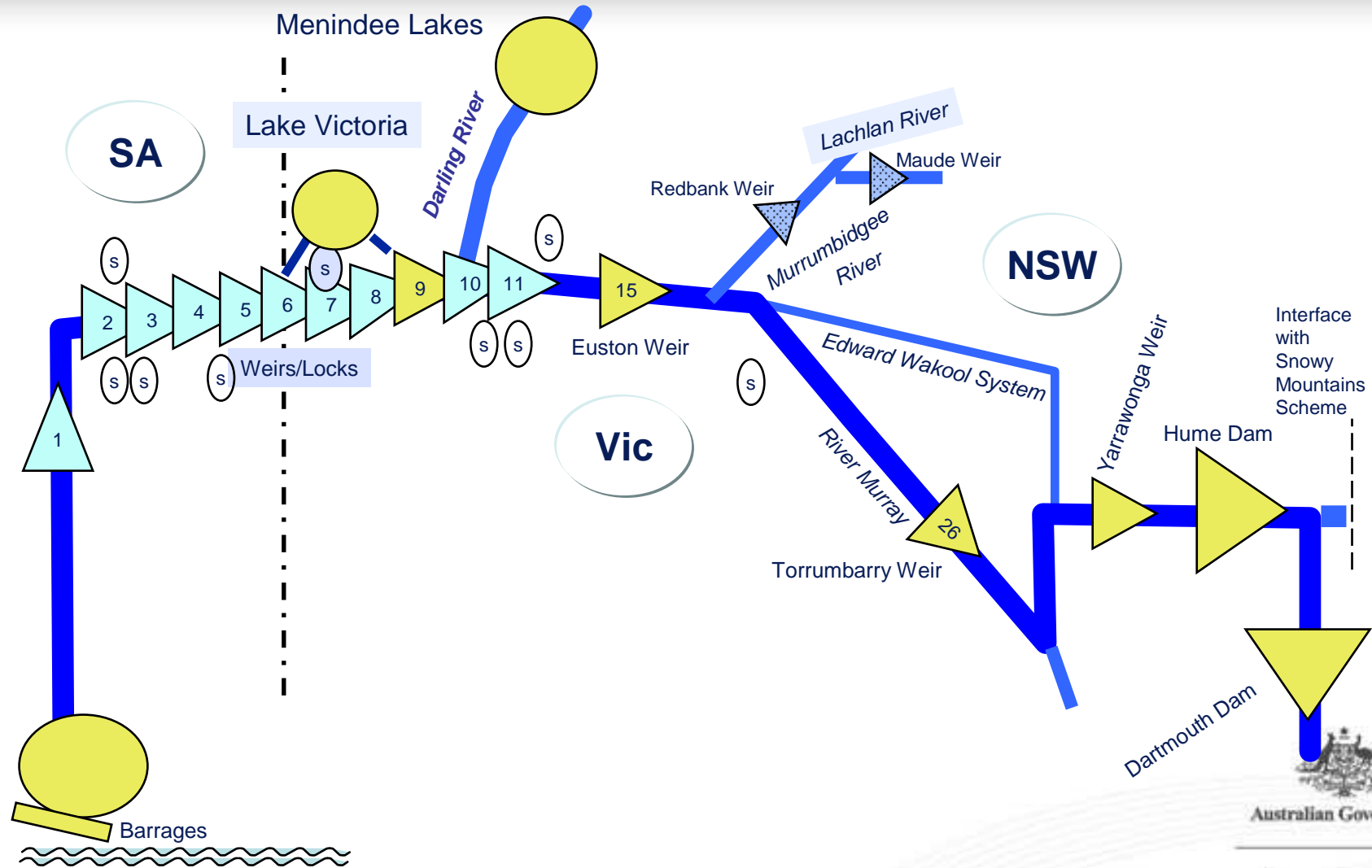

Modelling Framework

**Tributary
Models**

Murrumbidgee,
Goulburn-Campaspe-Loddon
Barwon-Darling + Tributaries
Snowy

MSM

Monthly Simulation Model
Demands, allocations, system operation

BIGMOD

Daily flow and salinity model
Flood operation, environmental flows
and levels, salinity

**Post
Processing**

Analysis of Results
Environmental Indicators

MFAT
Archiving



Australian Government



Modelling Modes

- **Water Resources Planning** (Testing options over 114 years – 1895-2009)
- **Short Term Planning** (1-5 years starting from current conditions (114 replicates))
- **Flow and Salinity Forecasts** (Up to 6 months in advance)



Australian Government



Processes Modelled

- **Water Resource Assessment**
- **Sharing Water between States**
- **Allocating Water to Users**
- **Demand Estimation**
- **Ordering water from storages**
- **Storage Operation**
- **Environmental Flow Rules**
- **Flow and Salinity Routing**
- **Water Accounting**



Australian Government



Schematic representation of part of the River Murray System for BIGMOD Model

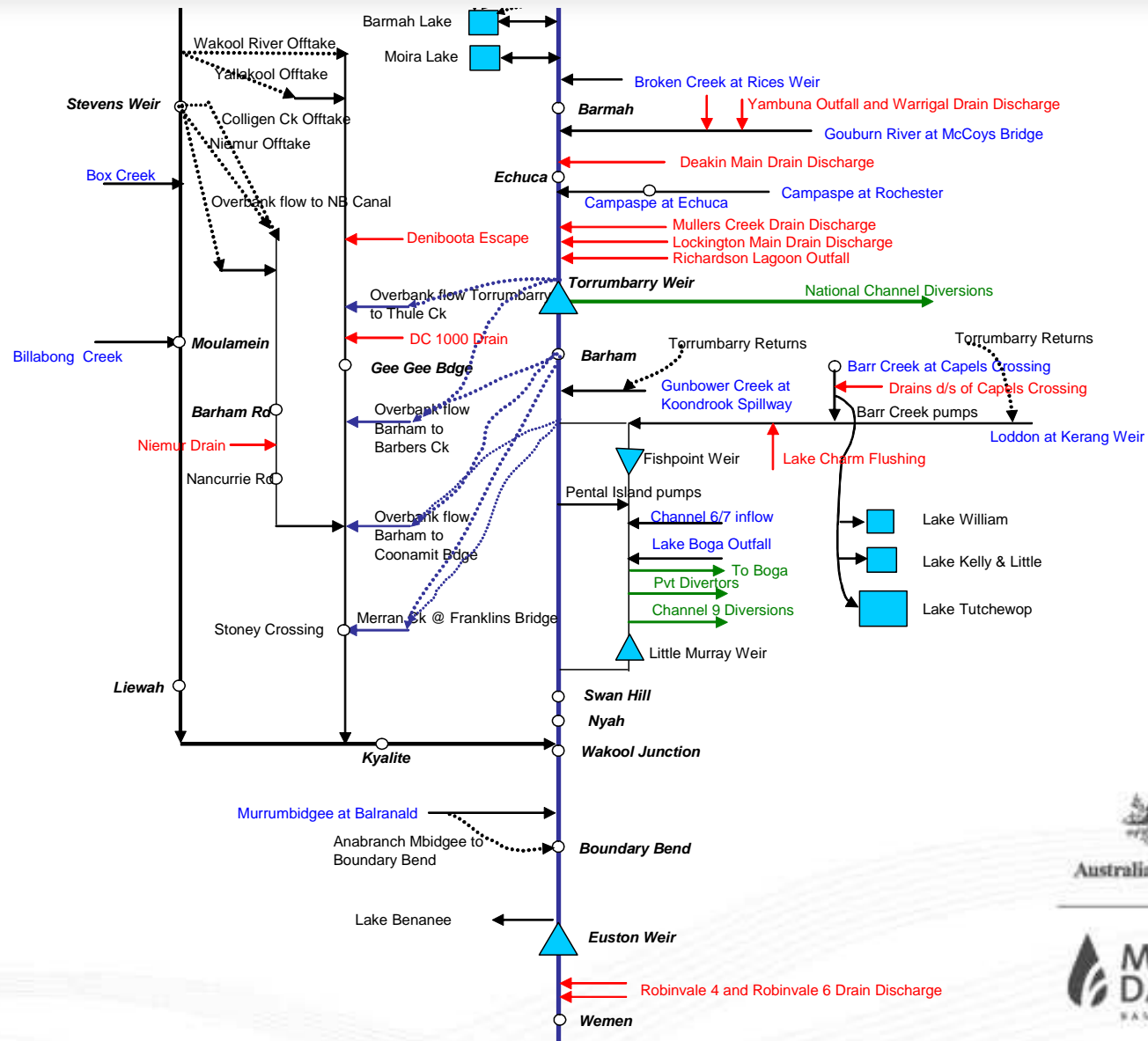

Australian Government



MSM Model Calibration

Comparison of Modelled and Observed Hume Storage Volumes

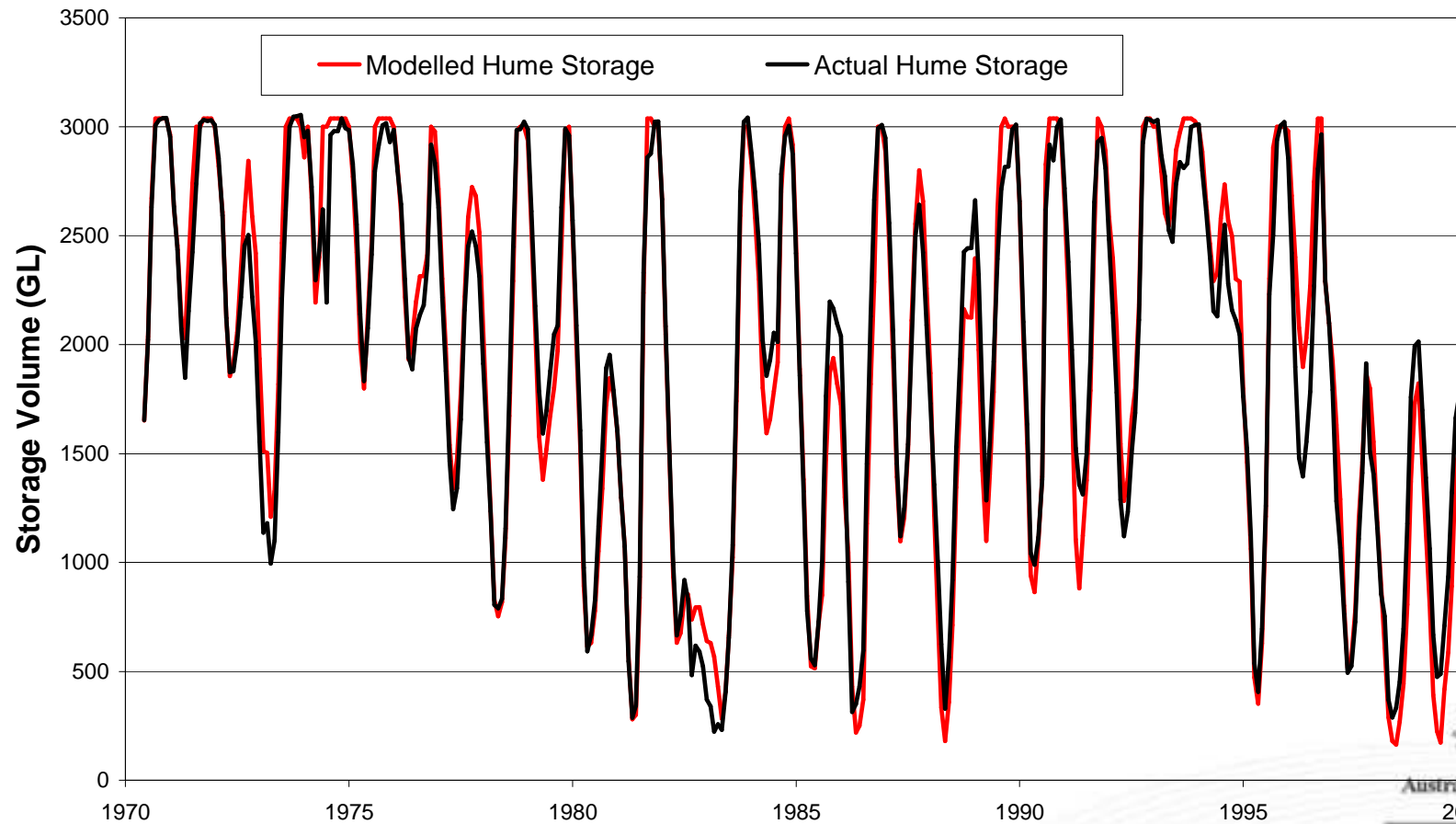

Bigmod Daily Flow Calibration

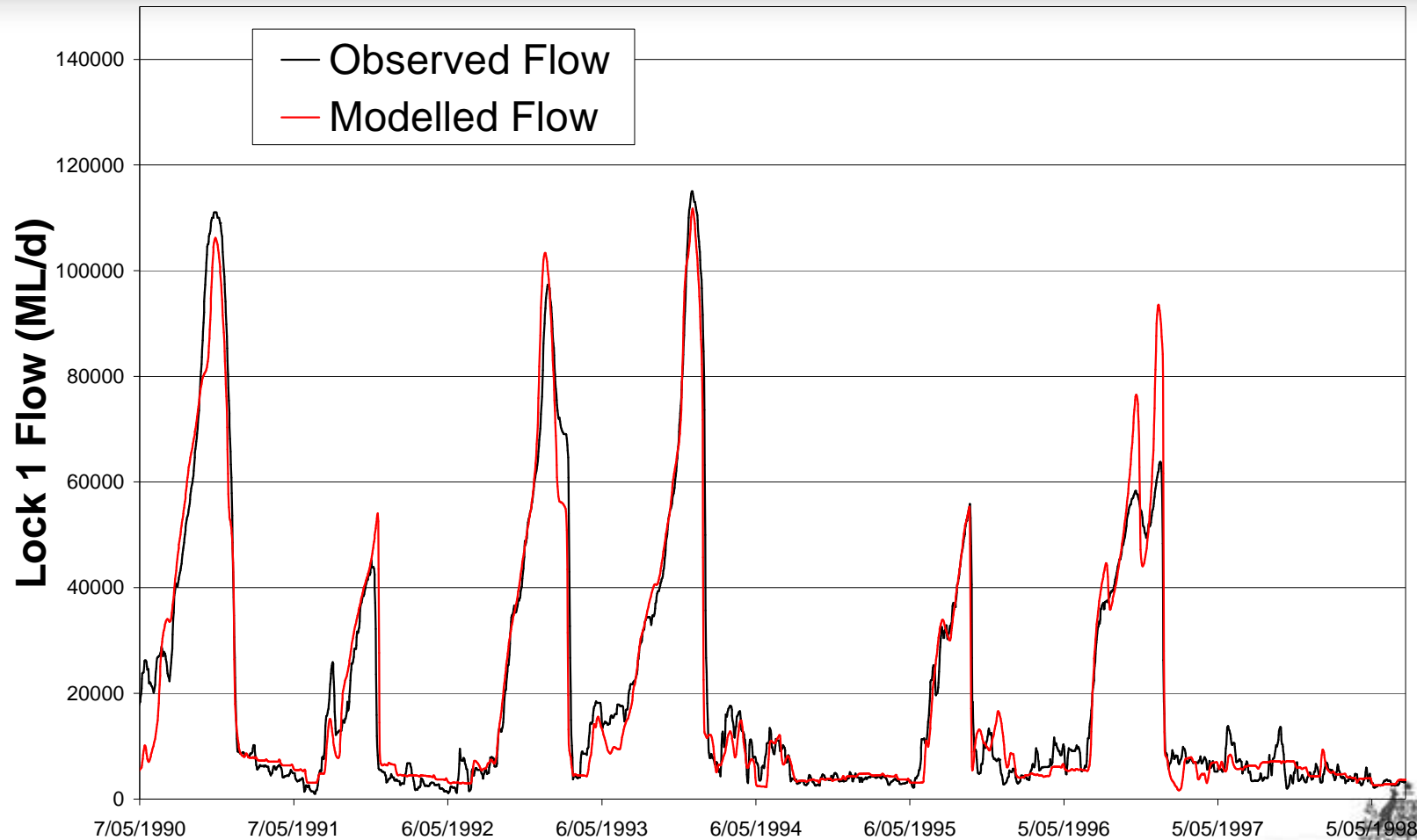

Australian Government

Model Calibration

Comparison of Modelled and Observed Morgan Salinity

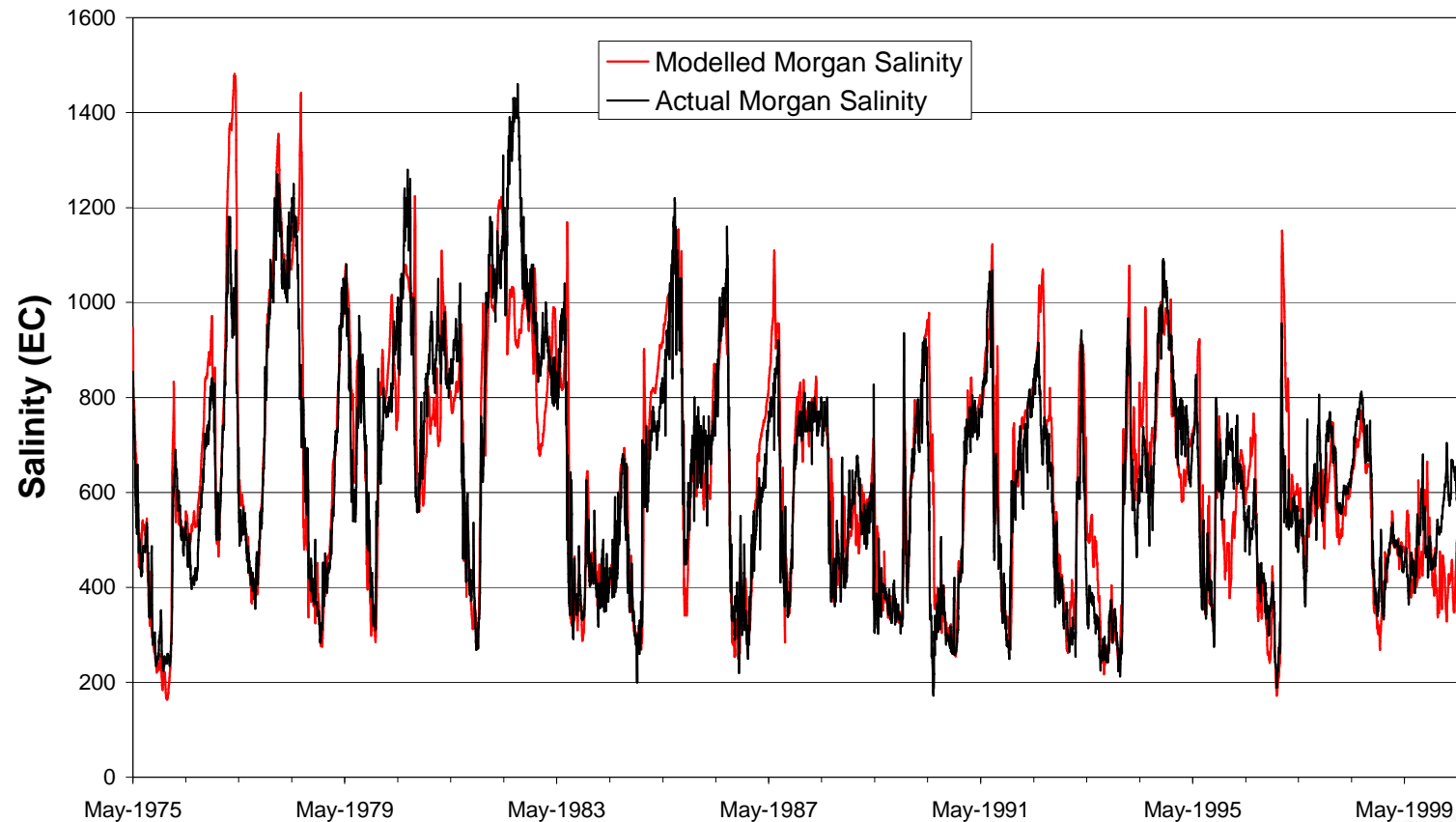

Australian Government



Level Calibration

Modelled and Observed Lock 6 D/S Level

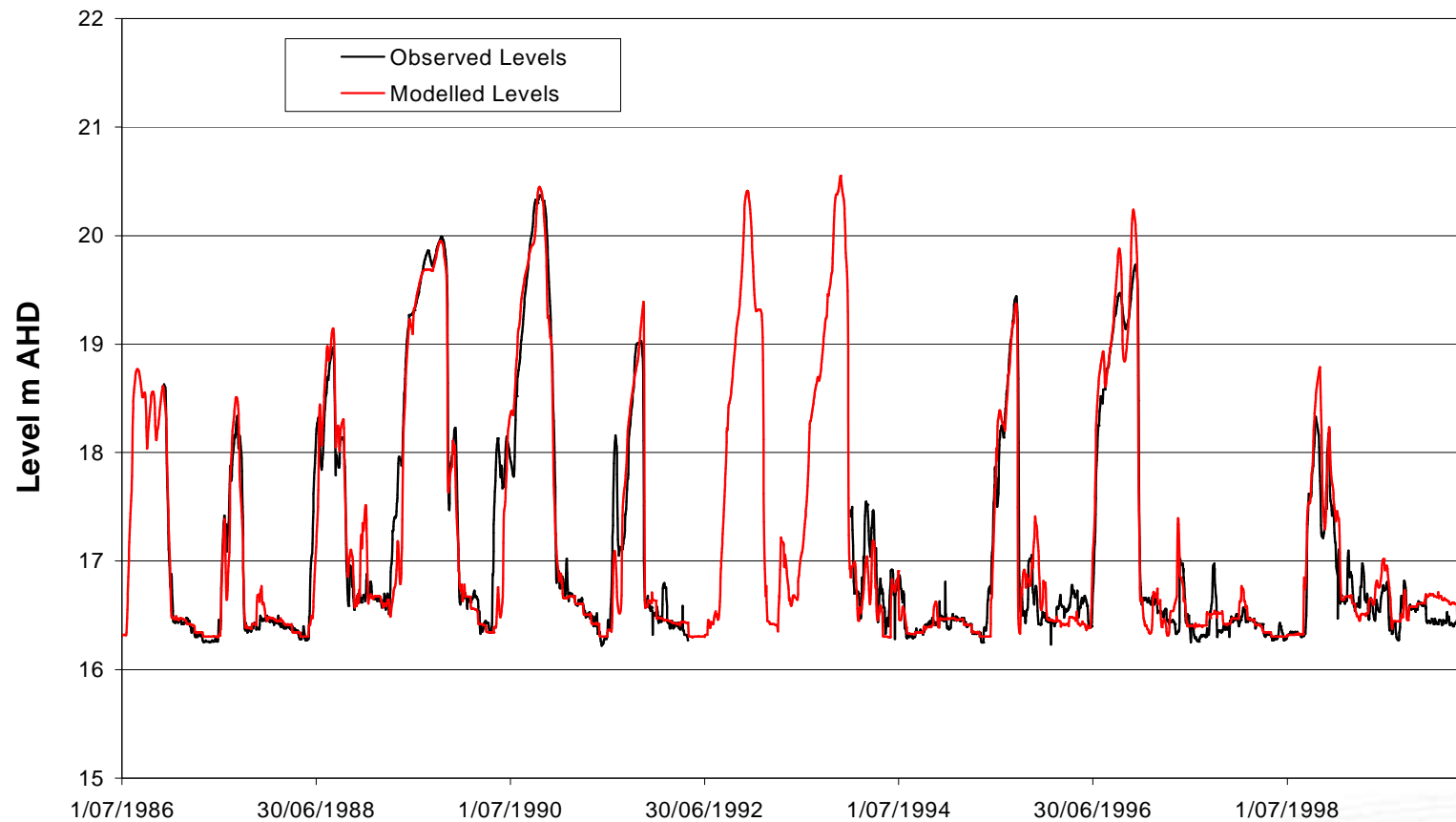

Australian Government



Applications of the models

Assessment of management options:

1. Water accounting and rules for sharing between States
2. Salinity management
3. Storage operation
4. Allocations by States to users including: allocations, off-allocation access and carry-over.
5. Environmental water recovery and the use of environmental entitlements
6. Water planning



Australian Government



NSW Reliability of Supply

NSW Demand versus NSW Supply

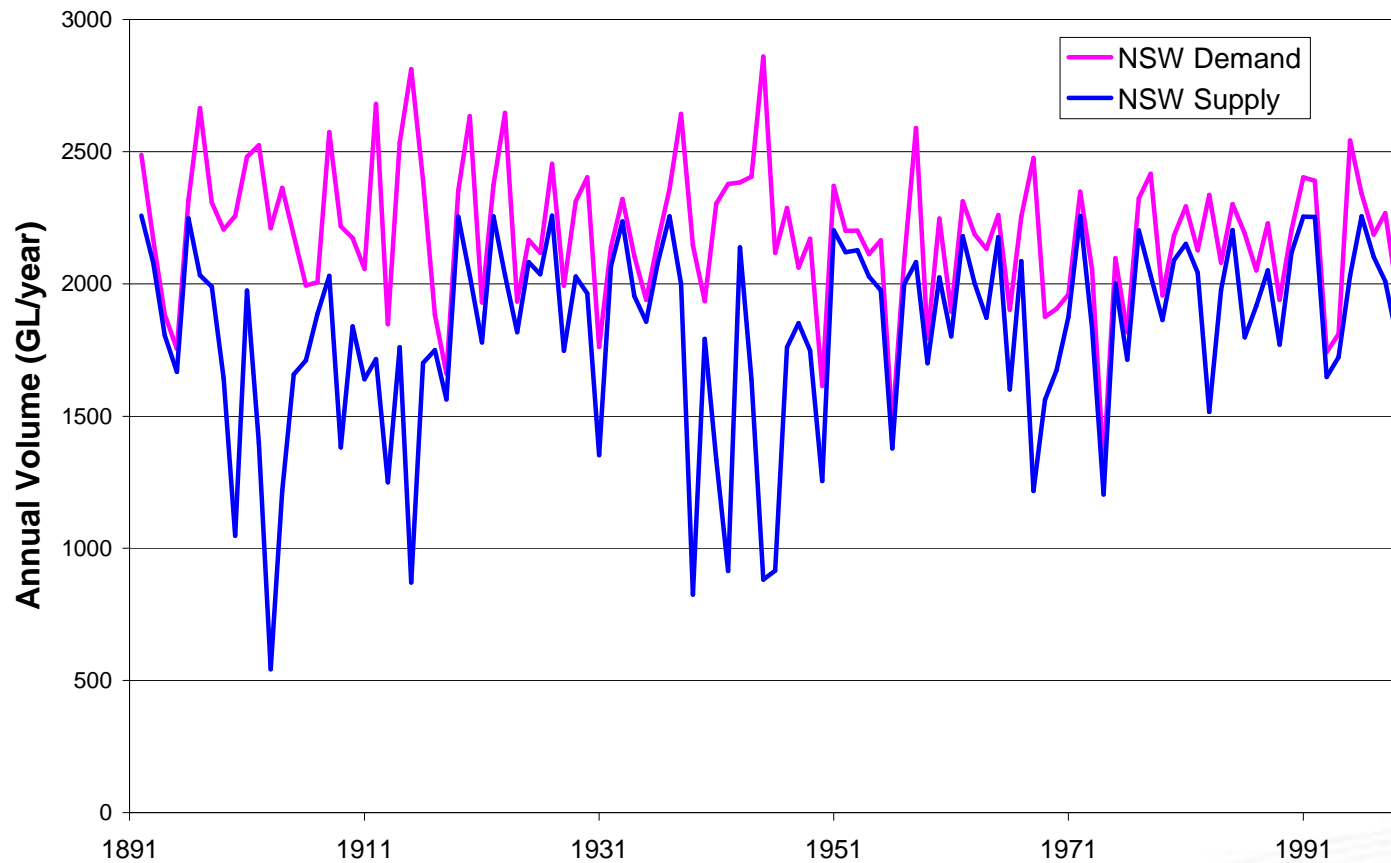

Australian Government



Reliability of Different Entitlement Products

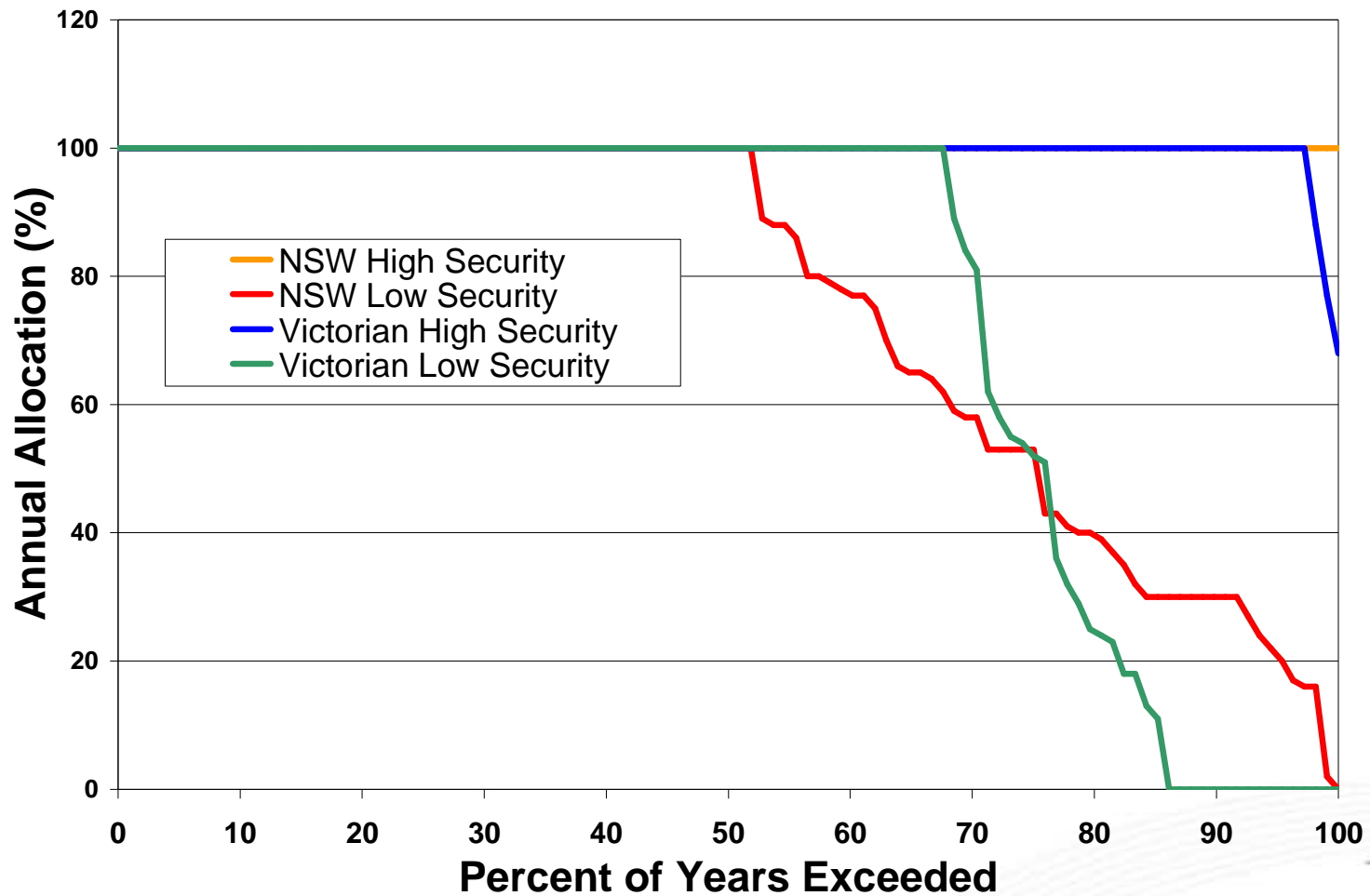

Australian Government



Water Accounting

- The water sharing rules were developed using the Authority's Monthly Simulation Model
- When it came to implementing those rules it was easier to use a version of the model where diversions, releases and storage operation were fixed to historical values read in from a special input file
- Monthly accounts have now been kept using this method for 21 years.



Australian Government



Water Accounting

January 2006 Operational Accounts

System Inflows	TOTAL	NSW	VIC
Murray Inflows	188.5	63.6	124.9
Inflow to Menindee	16.7	16.7	
Sub Total	205.2	80.3	124.9
Release from Murray1	107.0	67.0	40.0
Total	312.2	147.3	164.9

Menindee Lakes

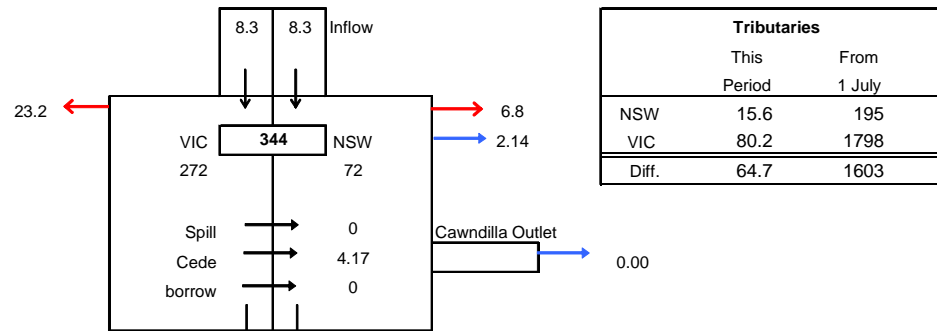

	Tributaries	
	This Period	From 1 July
NSW	15.6	195
VIC	80.2	1798
Diff.	64.7	1603

Lake Victoria

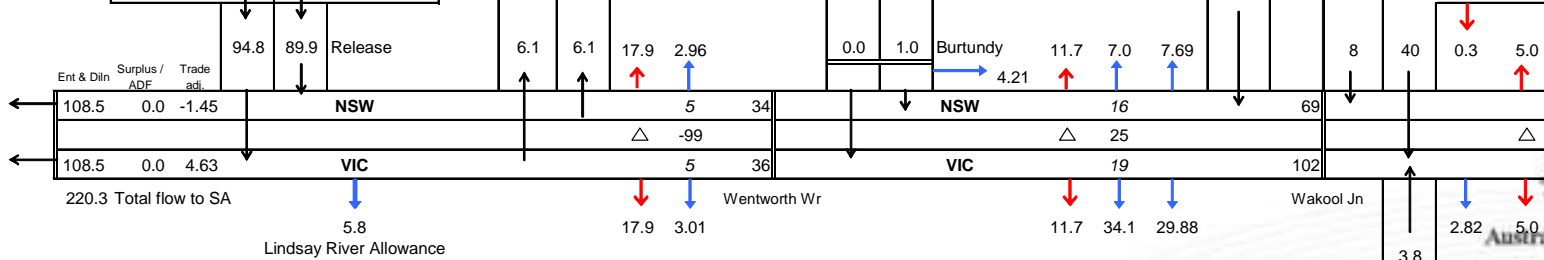
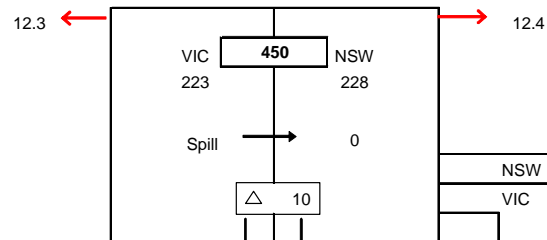

1E-14 Sum of discrepancies - system
-83.01 MSM discrepancy

Torrumbarry
Gross Returns



Basin Salinity Management Strategy

SA concerned with high salinities

Upper States concerned with high watertables

System of salinity accountability developed

- Models used to assess salinity credits from salt interception works

- Models used to assess salinity debits from drainage works and from new irrigation development

River Salinities have been substantially reduced



Australian Government



Salinity in Recent Drought

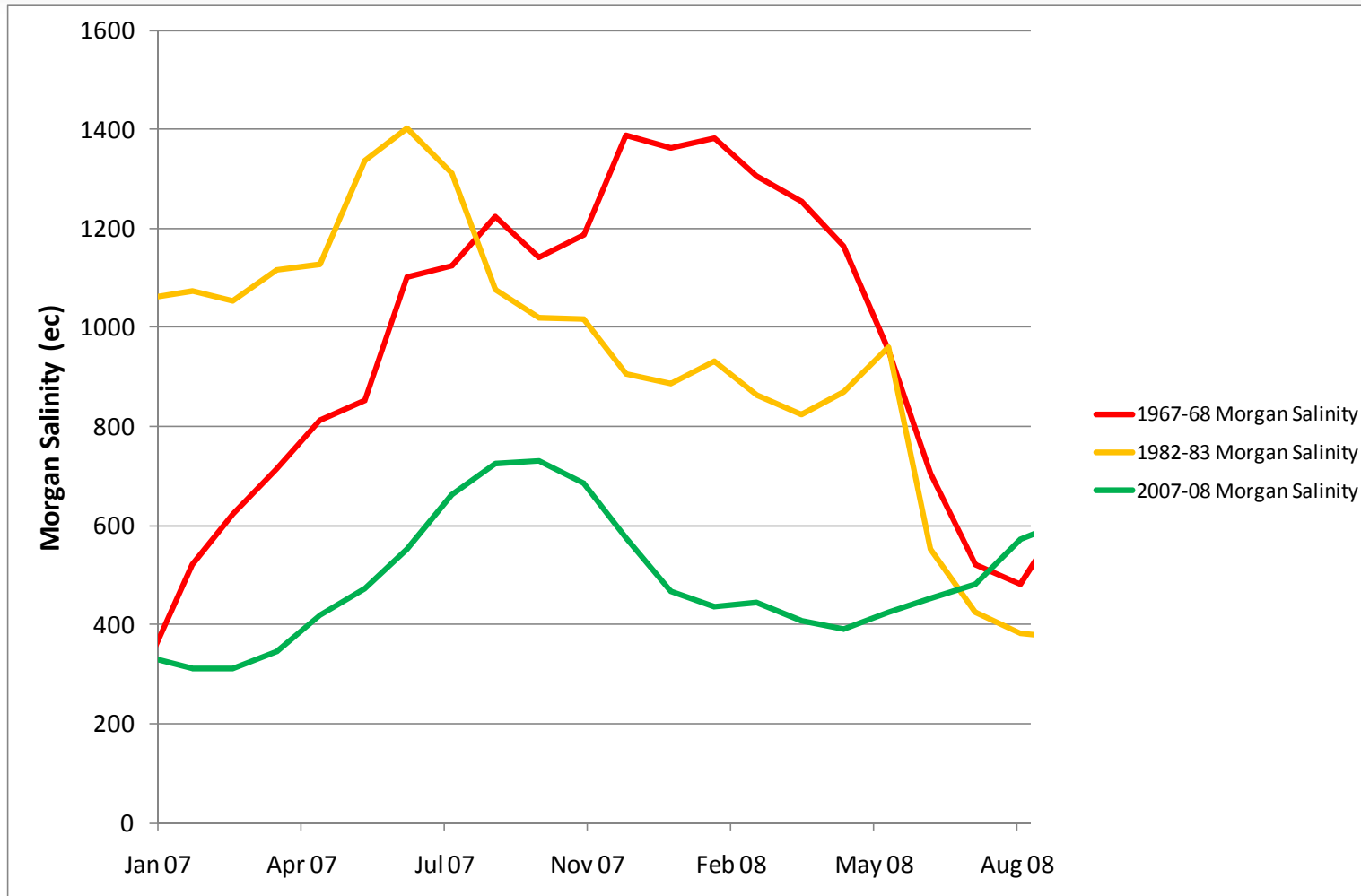

The Cap on Diversions

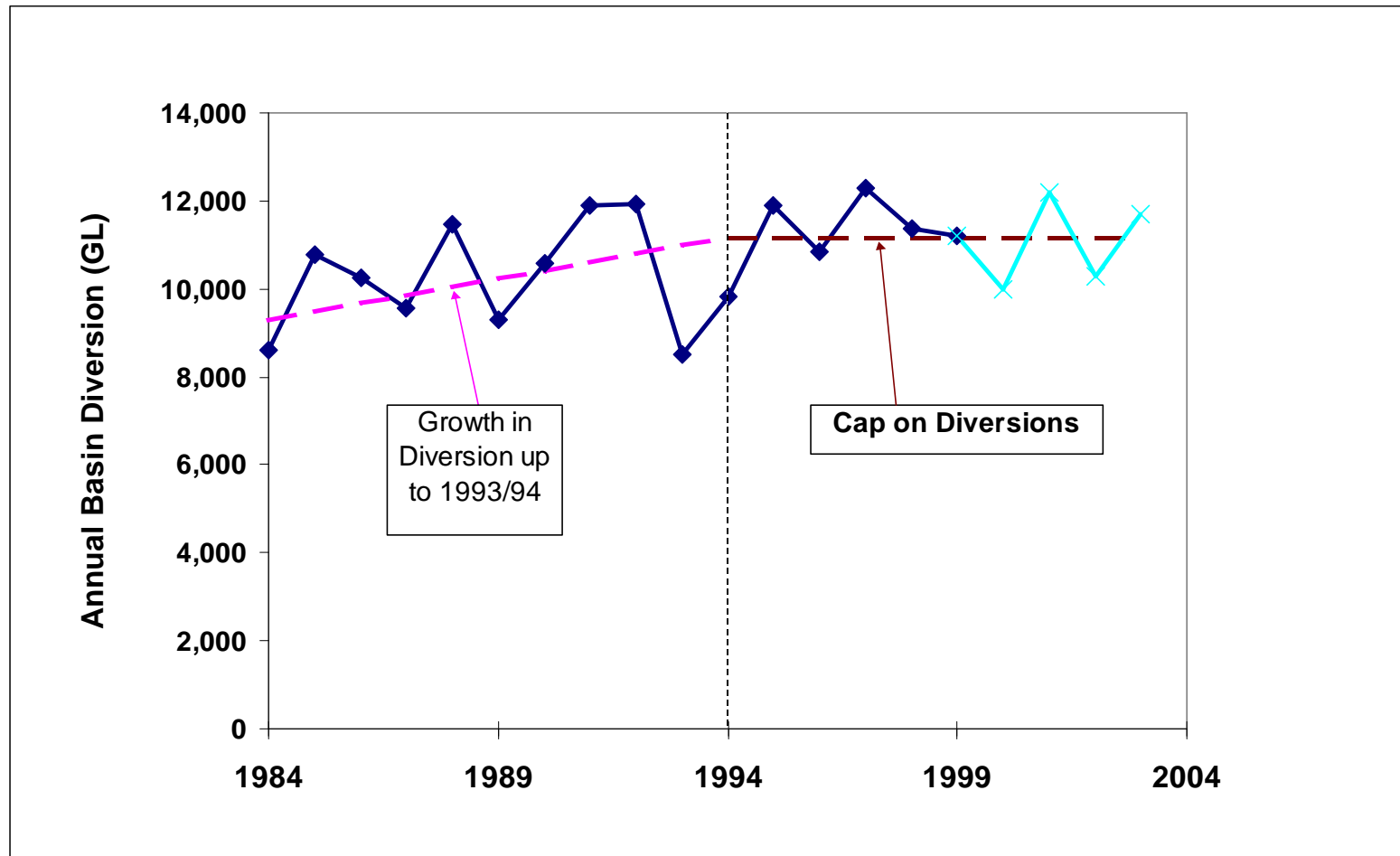

Demand Models

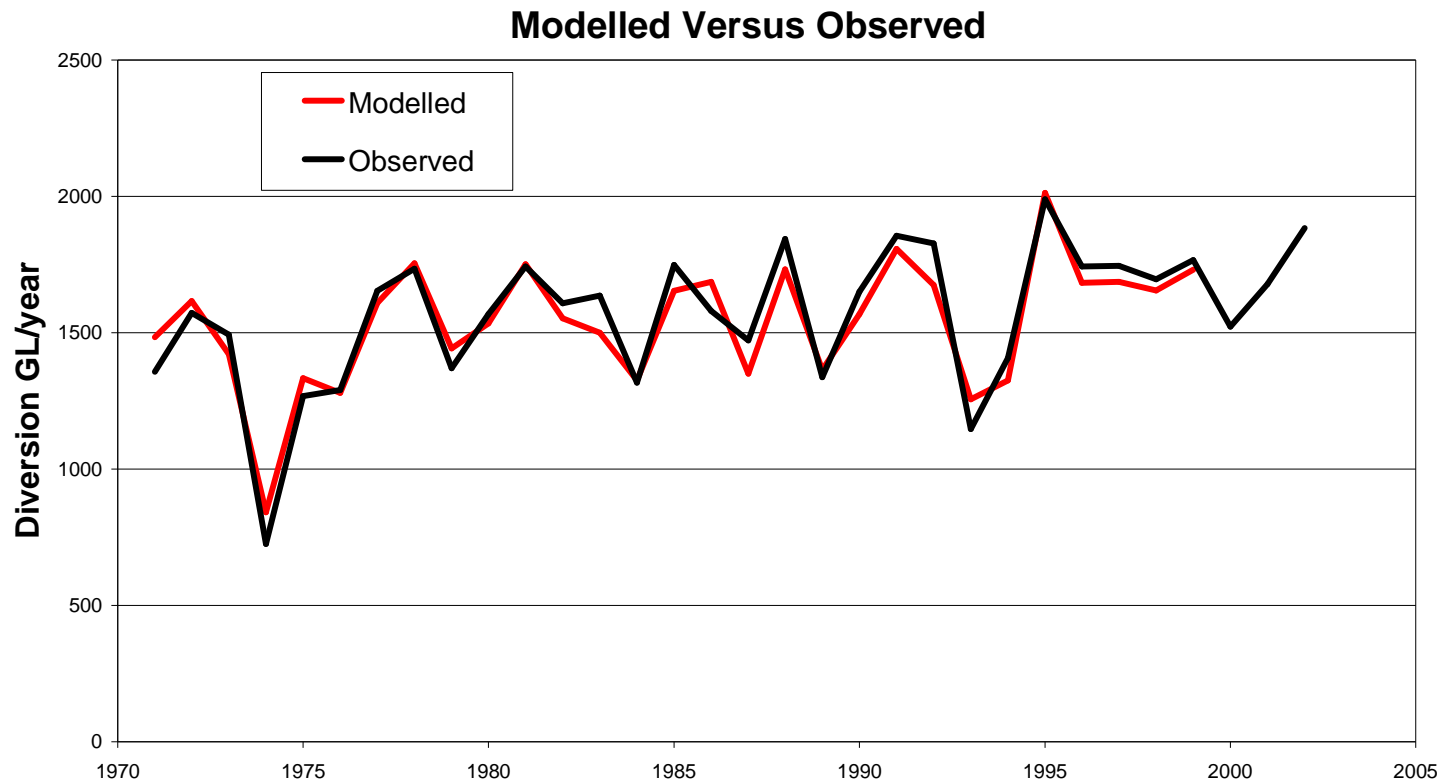

dent

Cap Register

Cumulative Cap Credits (GL/year)

System	Long Term Cap	Schedule F Trigger	1997-98	1998-99	1999-00	2000-01	2001-02	2002-03	2003-04	2004-05	2005-06	2006-07	2007-08	2008-09
			New South Wales											
Intersecting Streams	n/a	n/a	n/a	n/a	n/a	n/a	n/a	n/a	n/a	n/a	n/a	n/a	n/a	n/a
Border Rivers	202	-40	-36	-38	-89	n/a	n/a	n/a	n/a	n/a	n/a	n/a	n/a	n/a
Gwydir	344	-69	71	36	77	-31	-60	135	116	114	194	129	116	158
Namoi/Peel	338	-68	27	20	15	-1	-31	-50	-11	52	110	74	96	153
Macquarie/Castlereagh/Bogan	468	-94	-57	139	113	167	147	8	57	121	284	153	296	335
Barwon-Darling/Lower Darling	310	-62	-49	-13	22	-7	-18	-22	-105	-157	-139	-142	-183	-186
Lachlan	334	-67	-5	26	-5	-31	-41	-50	-17	7	46	59	108	127
Murrumbidgee	2358	-472	-29	16	163	137	461	784	893	685	964	1093	1379	1419
Murray	1880	-376	-65	94	622	558	331	-155	110	297	339	-99	133	146
Total NSW	6235	-1247	-142	281	919	791	790	649	1043	1118	1799	1266	1945	2153
Victoria														
Goulburn/Broken/Loddon cap valley	2034	-407	71	26	62	172	59	-12	14	122	118	87	179	214
Campaspe	122	-24	34	39	42	32	14	25	32	62	81	87	106	125
Wimmera-Mallee	159	-32	-1	29	65	72	76	86	86	114	99	102	99	111
Murray/Kiewa/Ovens Cap valley	1702	-340	106	39	93	140	50	206	277	373	509	547	695	657
Total Victoria	4017	-803	210	134	262	415	200	305	409	670	808	823	1079	1107
South Australia														
Metro-Adelaide & Associated Country Areas			128	84	74	109	31	31	111	187	232	100	164	87
Lower Murray Swamps	94	-19	0	0	0	0	0	0	0	0	0	0	-6	-8
Country Towns	50	-10	15	28	42	54	56	56	61	65	67	67	67	67
All Other Uses of Water from the River Murray	450	-90	28	64	137	180	224	269	341	339	370	407	479	616
Total South Australia	594	-119	171	176	253	343	312	356	513	592	670	574	705	762
Queensland														
Condamine/Balonne	n/a	n/a	n/a	n/a	n/a	n/a	n/a	n/a	n/a	n/a	n/a	n/a	n/a	n/a
Border Rivers/Macintyre Brook	250	-50	n/a	n/a	n/a	n/a	n/a	n/a	n/a	n/a	n/a	n/a	n/a	0
Moonie	34	-7	n/a	n/a	n/a	n/a	n/a	n/a	n/a	n/a	n/a	n/a	n/a	n/a
Nebine	6	-1	n/a	n/a	n/a	n/a	n/a	n/a	n/a	n/a	n/a	n/a	n/a	n/a
Warrego	48	-10	n/a	n/a	n/a	n/a	n/a	n/a	n/a	n/a	n/a	n/a	n/a	n/a
Paroo	0.078	0	n/a	n/a	n/a	n/a	n/a	n/a	n/a	n/a	n/a	n/a	n/a	n/a
Total Queensland	338	-68	0	0	0	0	0	0	0	0	0	0	0	27
Australian Capital Territory														
	40	-8	8	26	36	36	37	47	63	73	81	107	118	130
Total Basin	11224	-2245	247	617	1470	1585	1338	1357	2028	2453	3358	2770	3847	4179



Australian Government



Cap Compliance in MDB since 1997/98

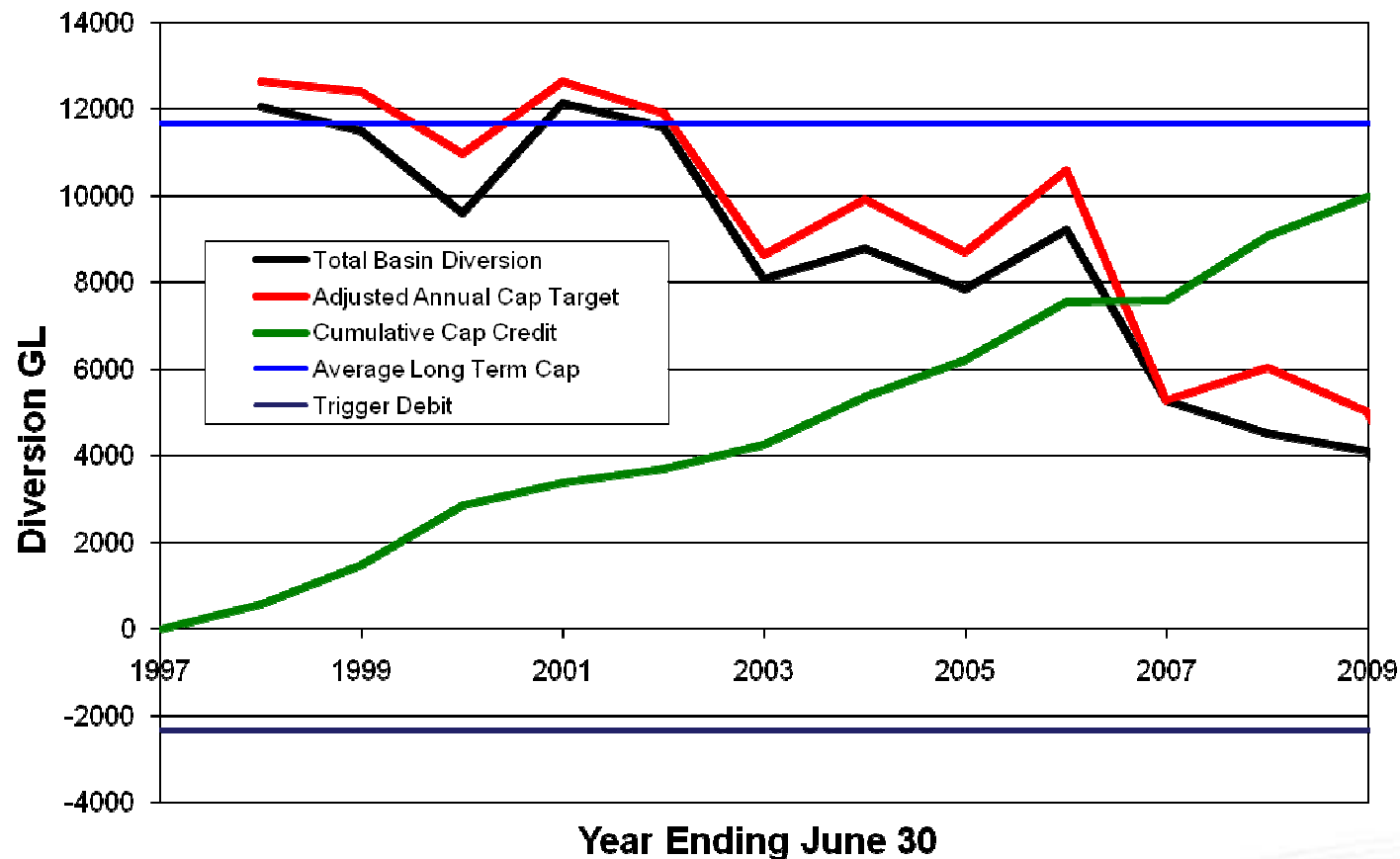

Australian Government



Climate Change Modelling

- **Current approach to Climate change modelling developed for the CSIRO Sustainable Yields Study in 2008**
- **15 Global Climate Models with 3 different CO2 forecasts**
- **90% exceedence, median and 10% exceedence rainfall estimates from 45 GCM runs used to define 'Dry, median and wet'**
- **Statistics averaged from 2015 to 2045 to define '2030' conditions**



Australian Government



Climate Change Modelling

- **Modelled change in rainfall used to scale up the historical streamflow sequences. Scaling applied initially on summer, winter, spring and autumn inflows and finally on annual inflows**
- **GCM modelled changes to temperature, rainfall and evaporation also applied**



Australian Government



Climate Change Modelling

- **Four model scenarios used:**
 - **Historical climate (114 years from 1895-2009)**
 - **2030 Median – Most likely estimate of 2030 conditions**
 - **2030 Dry – used for testing Critical Human water Needs reliability**
 - **2030 Wet – used to demonstrate uncertainty**



Australian Government



Modelled Flow to SA (GL/month) for Different Climate Scenarios

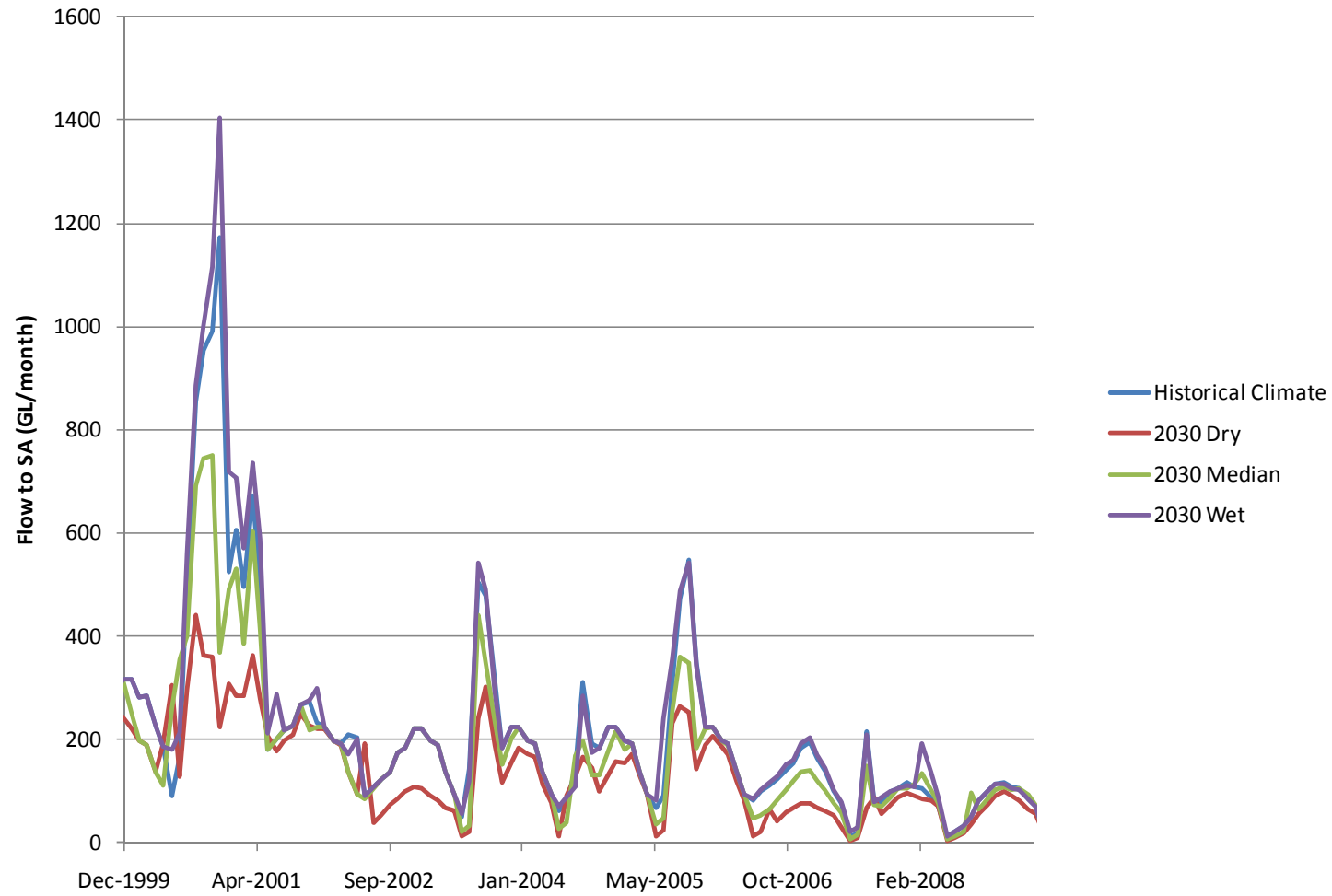

Australian Government



Conclusions

1. Models have a long history of use within the Murray-Darling Basin
2. Most important water management decisions are based to some extent on modelling
3. Some strategies such as the Cap, the Basin Salinity Management Strategy and Continuous Water Accounting based on Registers maintained by the models.
4. Usefulness of models dependent on the credibility of the modellers. Credibility is an outcome of model calibration, the ability of the modeller to understand and explain the model results and by the dedication of the modeller to track down and correct model bugs.
5. The increasing complexity of the interactions between river valleys (trade, environmental flows, Basin Plan etc) is leading us to connect up the individual river valley models to create a Basin Model.



Australian Government

